

>>PCN01<sup>3</sup>sp<sup>2</sup> >>PCN02<sup>3</sup>sp<sup>2</sup>

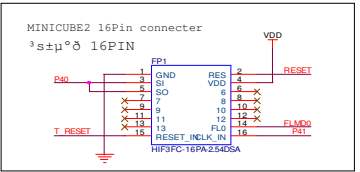

SW «áπT-Ó¶}Äö«O`d

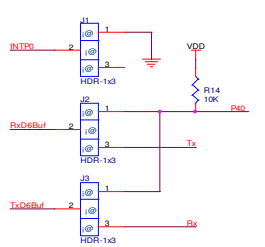

DC5V\_Input

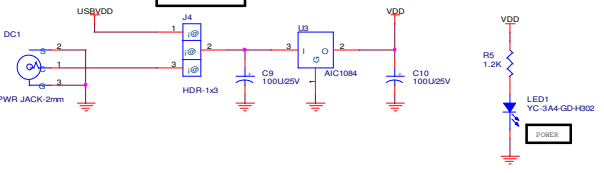

USB

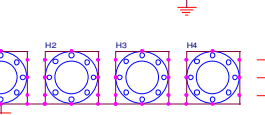
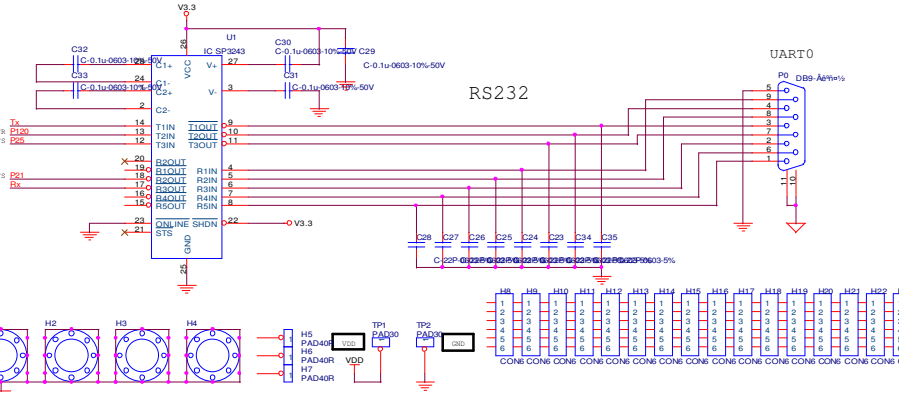
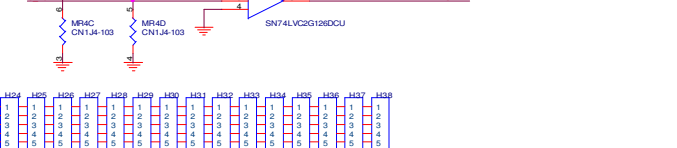
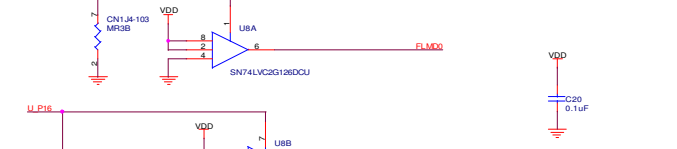
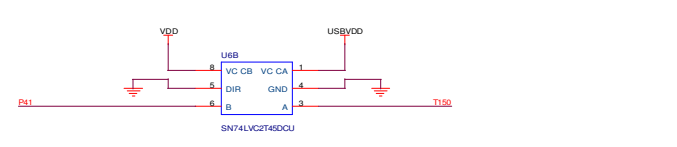
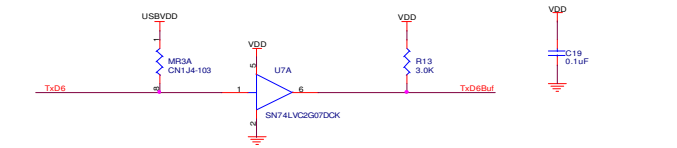
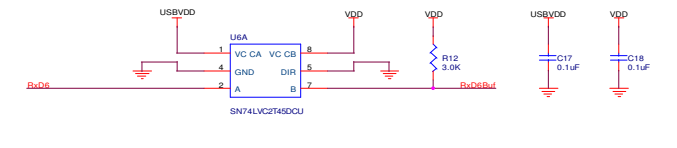
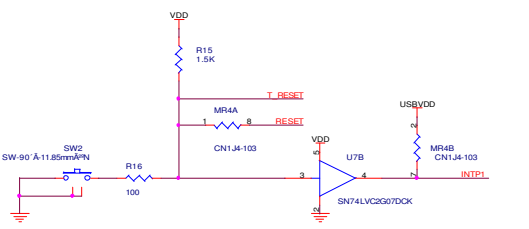
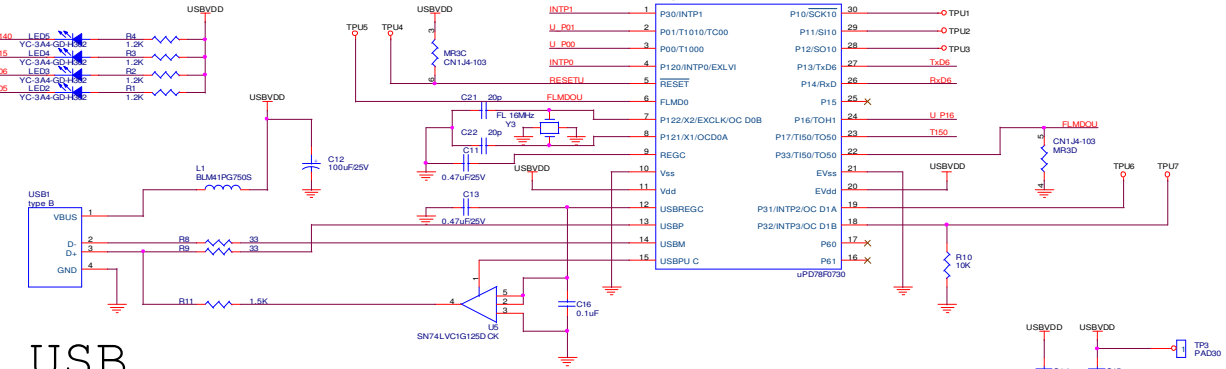

TPU1 ~ TPU9  
-°ü,Ö±μ,}

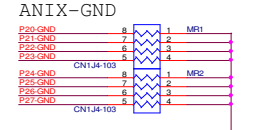
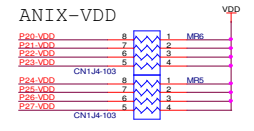

Analog Input

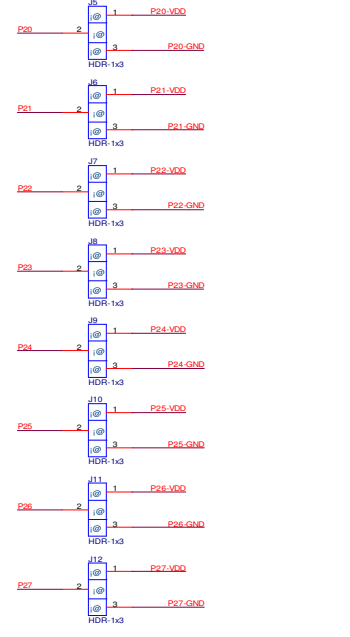

|         |                              |       |        |
|---------|------------------------------|-------|--------|
| Title   | <Title>                      | Rev   | <Rev>  |
| Size A2 | Document Number              | <Doc> | <Code> |
| Date:   | Wednesday, February 04, 2009 | Sheet | 1 of 1 |